



ML Filter Filter glasses

Multilens is a
unique company
within special
optics

It all started in a garage

Multilens is a world-unique specialist company within the optical sector. We tailor optical solutions for every need. From the beginning, our only goal has been to focus on the eyes, vision and visual function.

Multilens was set up in 1983 by Lars Hellström, who after 35 years in the optical business decided to focus on the most exciting challenge: developing special optic solutions that could solve difficult optical problems. Together with opticians, optometrists, eye care practitioners and eye doctors he created innovative special optics. Within a short space of time the whole Hellström family was committed and Multilens have since become leaders in low vision optics, helping thousands to enjoy a better visual experience.

Filter glasses can also be very beneficial to people with normal vision. They give your eyes the best protection against harmful light and the level of comfort is higher, meaning you never have to squint or suffer from sunlight-induced headaches. Another benefit is improved contrast vision.

We call it 'High Vision'.

Need more information?

Do you have questions about our products or need more information? Contact us or check out our website.

Web: www.multilens.com

E-mail: info@multilens.com

Tel: **+46 31 88 75 50**

TABLE OF CONTENTS



About ML Filter	
What is light	5
What is ML Filter	6
Our standard filters	7
ML Filter & polarized lenses	8
Filter & Filter glasses	10
ML Filter for people with reduced and normal vision	11
Possible applications	12
ML Filter for an active lifestyle	13
ML Filter for everyday life	14
AMD Comfort	15
ML Night Cover	16
ML Bilux	18
ML Filter with RX lenses for large curved sports frames	19
ML Filter on contact lenses	20
Possible applications	21
ML Filter sunglasses	22
About our lenses	23
ML Filter categories	24
About our frames	25
Our standard products	
HorizOn	26
HangOn	26
Biocover	28
Cover 2/Cover Kid	30
Sun Guard	32
Sun Lady 1 & 2	34
Sun-V	34
Sun-6	34
Sun-7	34
Sun-2	35
Sun-3	36
Flip-up	38
Alex	38
Nelli	38

MLFILTER



It is important for visually impaired that the information reaching the retina is not unnecessarily disturbed. Blue light is often perceived as discomforting and glaring, so a filter that stops it from reaching the retina can therefore increase visual quality and comfort.

ML Filter is also beneficial for people with normal vision. It can relax eye strain in general, improve visual quality for sport activities, avoid headache due to computer work, improve vision during night driving and much more.

WHAT IS LIGHT?

LIGHT IS ELECTROMAGNETIC RADIATION

The visible light is part of the electromagnetic radiation. The wavelength decides the properties of the radiation. Electromagnetic radiation always moves in the speed of light, which means that there is a bound relationship between frequency and wavelength. The shorter the wavelength, the higher frequency and thus higher energy. The part of the spectrum that we call visible light has a wavelength of about 400-750 nm. The image below shows a rough breakdown of what we call the different parts of the electromagnetic spectrum. Please be aware that there are different ways of dividing the wavelengths of the various colors, and this is just one of them.

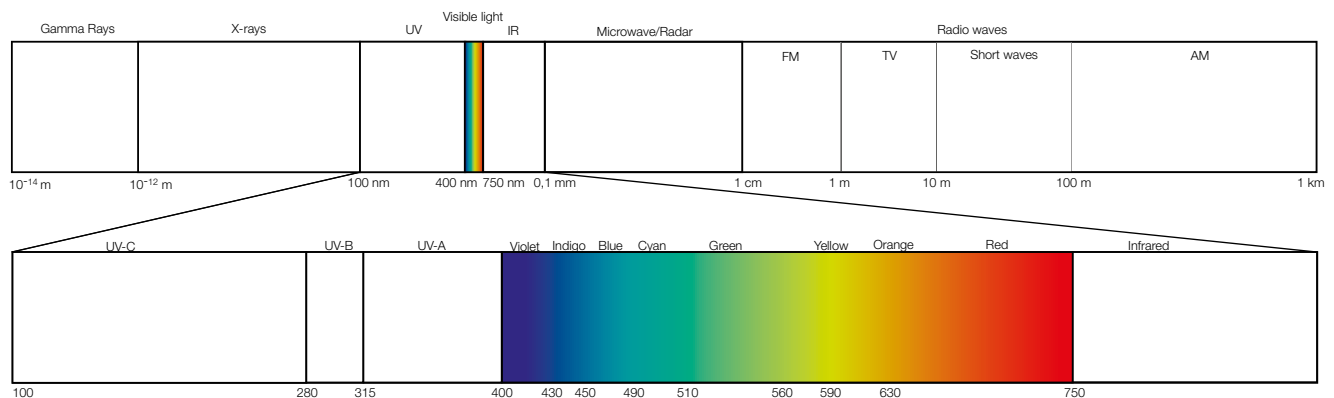

WHAT IMPACT DOES ELECTROMAGNETIC RADIATION HAVE ON OUR BODY

Depending on the wavelength, the radiation affects us in different ways. Generally speaking, the shorter the wavelength, the more impact it has on us. Gamma rays can kill living cells at a high intensity and X-rays in high concentrations may cause cancer. Radio waves at the other end of the spectrum hardly affects us at all, they pass through our bodies without much impact.

WHAT HAPPENS IN THE EYE?

The eye is affected in the same way as the rest of the body when exposed to electromagnetic radiation. The eye has to transmit and detect the visible light. This means that the UV-light also transmits and is allowed to affect the structures in the eye. UV-light speeds up the aging of the eye and may cause both cataract and macular degeneration.

When the visible light passes through the eye's refracting surfaces the different wavelengths are refracted differently due to colour dispersion. The blue part of the spectrum is refracted most and causes a distortion on the retina.

Studies show that short-wave blue light can be harmful in the same way as the UV-light, which means that there is a protective effect of filtering out blue light.

WHAT IS ML FILTER?

ABSORBING BLUE LIGHT

When light passes through the lens of the eye, the blue part of the spectrum scatters causing distortion of the image on the retina. The purpose of a filter lens is to block this light. Many people who have tried filter lenses experience increased comfort, sharpness and contrast. This is particularly true for visually impaired for whom it is very important that the information from the retina is as clear and sharp as possible.

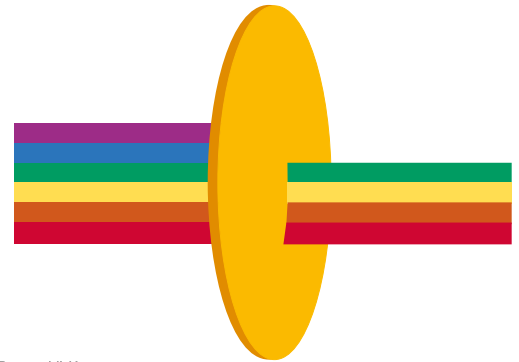

PROTECTION AGAINST BLUE LIGHT

Most clinical studies today show that if UV and blue light are allowed to pass through the lens onto the retina they can damage the retina. The degree of damage depends on the energy of the light which in turn depends on the wavelength. The shorter the wavelength, the higher the energy and the more damage the light causes. Studies suggests that blue light up to around 450 nanometres is also harmful.

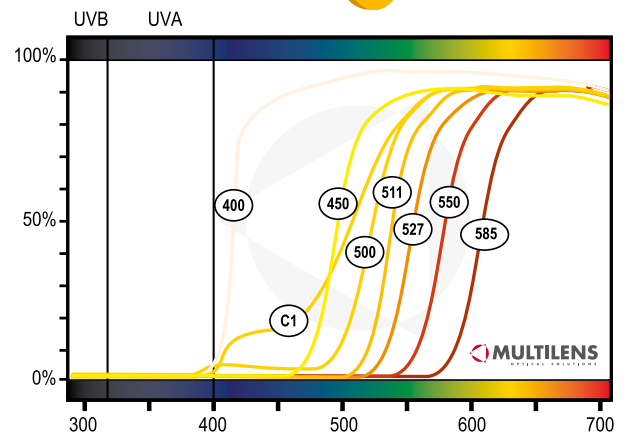

Illustration 1: ML Filter 400, C1, 450, 500, 511, 527, 550 & 585

ML FILTER WITH PRESCRIPTION

All ML Filters are available as an added feature on any prescription lenses. It is also possible to include ML Filter in our systems and reading glasses.

OUR STANDARD FILTERS

Multilens has a long experience in manufacturing filter lenses for both partially sighted as well as people with normal sight but with high demands. In illustration 1, 2 and 3 you'll find transmission graphs of our standard ML Filters and on the next page a description of each tint.

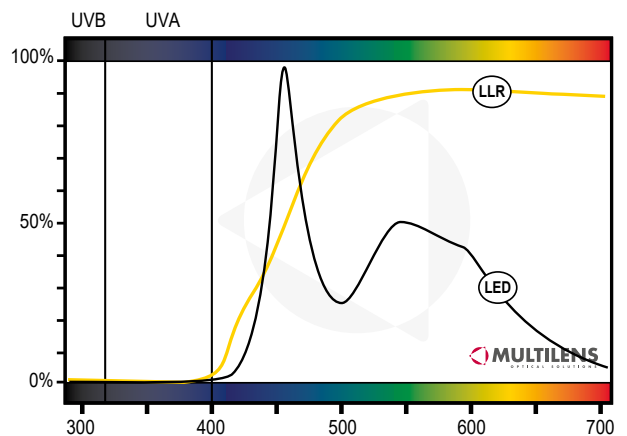

Illustration 2: ML Filter LLR

OTHER TINTS

We also tint standard colours such as brown and grey on our lenses. If you want a special tint, you are welcome to send us a colour sample. We can't promise that we will succeed every time, although in most cases the result is great.

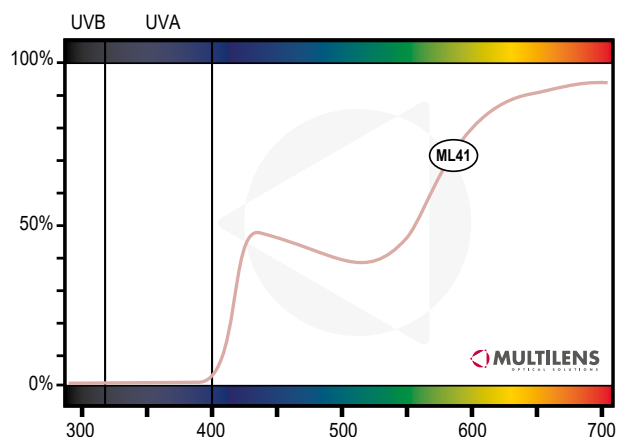

Illustration 3: ML Filter 41

OUR STANDARD FILTERS

			Recommended for		
			Work & leisure	Outdoor & sport	Reduced vision
	ML Filter 400	Lightly tinted lens that is comfortable and relaxing for most people. Absorbs some of the shortwave blue light. Colour: Light beige.	✓		
	ML Filter C1	Allows parts of the blue light transmits to maintain a natural color perception. Absorbs 80 % of the harmful shortwave blue light. Colour: Yellow.	✓	✓	✓
	ML Filter 450	Absorbs all of the harmful shortwave blue light. Colour: Lemon.		✓	✓
	ML Filter 500	Allows a small part of the blue light transmit to have some colour perception. Absorbs 95 % of all blue light. Colour: Yellow.	✓	✓	✓
	ML Filter 511	Orange lens. Absorbs all blue light. Colour: Orange.		✓	✓
	ML Filter 527	Absorbs all blue light and some parts of the green light. Colour: Dark orange.			✓
	ML Filter 550	A clearly red lens that absorbs all blue light and most of the green light as well. Colour: Red.			✓
	ML Filter 585	Dark red lens that only allows parts of yellow light and red light to transmit. Colour: Dark red.			✓
	ML Filter LLR	LED Light Reduction - Absorbs shortwave blue light with focus on eliminating the uncomfortable blue light from modern car head lights. It also increases the comfort for computer work. Colour: Light yellow.	✓	✓	
	ML Filter 41	Has been shown to provide increased comfort. Relieve migraine symptoms. Reduce visual stress, especially after brain traumas with some effect on the visual function. Reduce visual symptoms with blepharitis. Colour: Pink.	✓		✓

ML FILTER & POLARIZED LENSES

With the combination of filters and polarization, you get really high quality filter sun glasses. The polarization increases comfort thanks to elimination of disturbing reflections.



Our polarized lenses

The options below are available with prescription and with all types of lenses. The two versions of grey are possible to combine with ML Filter:

Pol 1 Grey (light) - 65% absorption

Pol 3 Grey (dark) - 85% absorption

Pol Brown - 81% absorption

Pol G15 - 85% absorption

The options below are only available with plano power and in our standard solutions:

Pol B - 90% absorption

Pol G - 80% absorption

Pol Y2 - 65% absorption

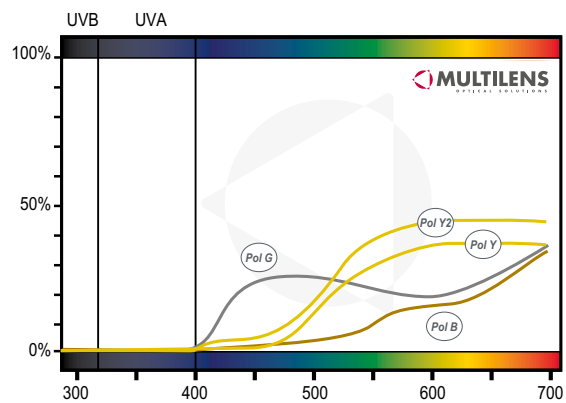
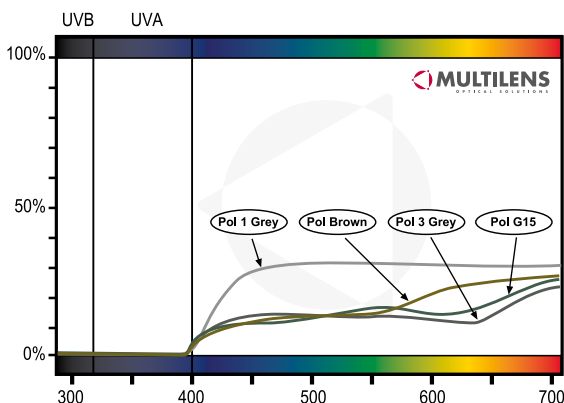

Drivewear

Drivewear lenses are capable of sensing and reacting to varying light conditions both outside and behind the windshield of the car. From bright sunlight accompanied by intense, blinding glare, to overcast conditions. Drivewear lenses provide the user with the appropriate visual solution. Drivewear lenses provide glare protection through polarization. The photochromatic effect provide excellent comfort at brightness level. In its faded state, the absorption is around 65 % and fully activated it is around 90 %.

Transitions

Transitions is a photochromatic lens that varies from full transmission to around 85 % absorption. Transitions XTRActive has a light base tint and varies in from around 20 % to 90 % absorption. Lenses with transitions always have 100 % UV protection.

- Transitions Signature Brown 3-85 % absorption
- Transitions Signature Grey 3-85 % absorption
- Transitions XTRActive Grey 20-90 % absorption

ML FILTER IN COMBINATION WITH POLARIZATION

The combination ML Filter and polarization is really powerful to obtaining high quality filter sun glasses for optimal comfort, contrast and protection. See below the transmission curves for some of our combinations.

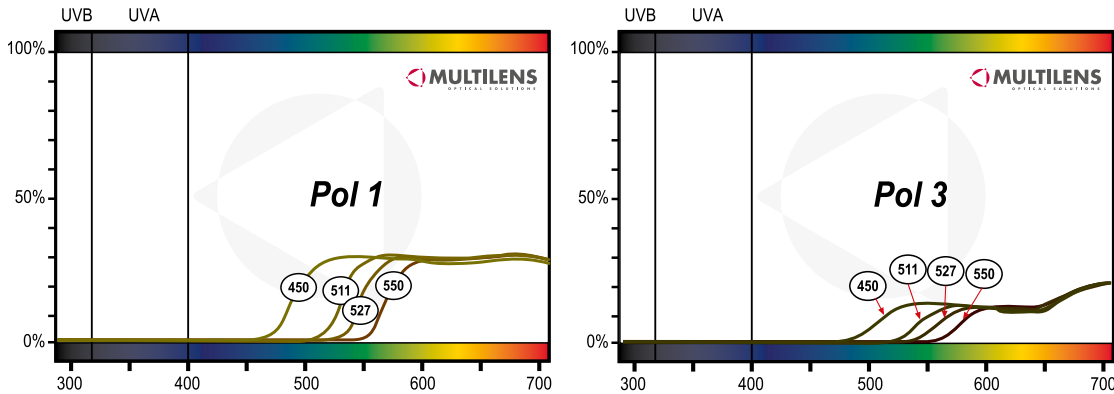

ML Filter in combination with photochromatic lenses

We use two different alternatives for photochromatic lenses, Transitions Signature and our PC photochromatic lenses. This means that the lens only has the filter colour indoors and gets darker when exposed to UV light.

ML Filter in combination with Drivewear

All our ML Filters can be combined with Drivewear but we recommend our C1 filter to utilize the best properties from both Drivewear lens and the filter.



FILTER & FILTER GLASSES

Most people who buy sunglasses primarily decide what to buy based on the look of the frame.

If the reason to buy a pair of sunglasses is to protect one's eyes and increase comfort, then they should start with selecting the lens.

The big difference between filter sunglasses and sunglasses is that filter sunglasses absorbs unwanted light and sunglasses absorbs a part of all light. You can compare it with advanced hearing protection that reduces the noise while letting all useful sound through (filter sunglasses) and a normal hearing protection that reduces all kind of sounds (sunglasses). You can also select different filter lenses in your filter sunglasses and thereby select what light should be considered as noise. This is extremely important because what we perceive as annoying light is individual.

In short, filter sunglasses give better protection, better contrast and more comfortable vision than normal sunglasses.



What difference does filter sunglasses mean for you?

The first thing you notice is that you can see better. Filtering out unwanted light only allows a greater amount of useful light to pass through to your eyes. This means that when you wear filter sunglasses, more light reaches your eyes (than when you wear normal sunglasses) and you don't experience any discomfort. As a result, you will see better. To give you an illustration – everything doesn't turn as black as night when you drive into a tunnel.

Even better vision when you need it

You choose filter lenses for your filter sunglasses, depending on when you're going to use them. If contrast is important, for example when you're skiing, a certain part of the light must be allowed to pass through. When you're driving, it's important with a different part of the light.

Glare reduction

All our filter sunglasses include a standard polarizing layer, which reduces bothersome glare and reflections. However, if you for some reasons don't want to eliminate glare, you can of course choose non-polarized filter lenses. Once again, it's all about choosing which "noise" you want to block out!

Optics according to requirements

Our 35 years of working with optics, light, filters and eyes have equipped us with an in-depth understanding of how different people have different needs when it comes to optics. That's why all our filter sunglasses are available in three classes, depending on visual sensitivity and requirements.

ML FILTER FOR PEOPLE WITH REDUCED VISION

With reduced visual function, it's usually really important with good lighting. However, many people experience intensive light disturbance and this can of course cause frustration. You need high intensity light in order to see, but the light level causes discomfort. One reason is that the feedback loop from cones to rods gets inhibited by the retinal degeneration, which makes the rods active also in bright light. We know that the rods are more sensitive to blue light. If we use glasses that absorbs the blue light we can increase the visual quality tremendously and eliminate the discomfort.



Another reason that blue blocking lenses is a good idea is to improve the protection of the eyes. We know that the short wave blue light is hazardous and can cause damage in our retinal cells. If there already is an ongoing degeneration in the retina, it's even more important to use the protection available.

For most of our products, it's possible to add ML Filter. Feel free to add ML Filter to your pair of ML Vidi, ML Focus, ML Binova etc.



ML FILTER FOR PEOPLE WITH NORMAL VISION

Even if there are circumstances where there is a need for a plain filter, it's mostly in combination with polarization that filter lenses is useful for people with normal vision. We call this Filter sunglasses and gives you enhanced contrast, increased comfort and better protection compared to normal sunglasses.

Brighter lenses with reduced glare issues

One of the biggest advantages of using filter lenses is that we can use brighter lenses (transmits more total light) and still obtain the desired effect (reduce glare). As an example, filter sunglasses normally don't feel too dark when driving into a tunnel.

Better protection

Filter sunglasses looks like normal sunglasses but have the additional feature of blocking the dangerous short wave blue light.

Filter sunglasses in high curved frames

We can produce lenses for curved frames even if the powers are getting quite high. In general, the thickness and not the diameter is limiting us in what we can do. For more information, see our product documentation for our lens program.

Customized filter sunglasses

If you don't wish to have polarization in your filter sunglasses, we can easily combine filter effect and a grey tint to desired level of darkness. We can also produce really dark lenses with filter effect for circumstances where extra sun protection is needed.

POSSIBLE APPLICATIONS

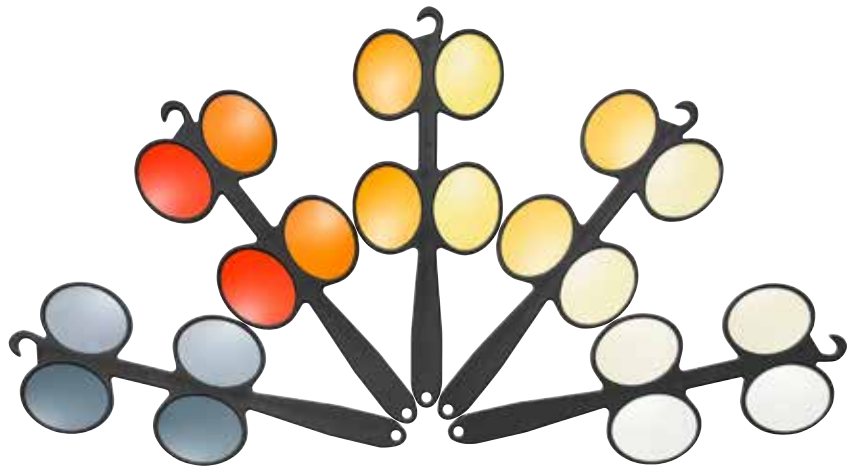

The possibilities with ML Filter are endless. ML Filter could help people see better in daylight and in night time. It can make seeing more comfortable both indoors and outdoors. It can help you sleep better or help you avoid getting tired. It can make you experience the day sunnier or cloudier. And a lot more.

In this chapter we try to inspire you to see all possibilities with ML Filter.

ML FILTER FOR AN ACTIVE LIFESTYLE

Whether your favourite outdoor activity is extreme skiing, beach volleyball or fly fishing, the ML Filter Sunglasses will enhance your experience through better comfort and contrast. At the same time, they will protect you far beyond what ordinary sunglasses would do.

With ML Filter Sunglasses it's possible to spend many hours in very bright sunlight, without ever squinting or suffering from headaches.

Sailing/Kayaking

Due to water's reflection, all kinds of watersports mean exposure to extreme levels of brightness – even on cloudy days. For a sunny day at sea, a lens with dark polarization (Pol 3) combined with ML Filter 500 or 511 is recommended. For less extreme exposure to light, ML Filter C1 combined with a lighter polarization (Pol 1) works fine.



Winter

For all winter sports it's especially important to protect your eyes – since the brightness on a sunny day with fresh snow can be 10 to 15 times more powerful than the level of brightness your eyes can handle. The 450 lens combined with a Pol 3 filter is a suitable combination which provides extensive protection and enhances contrast – very useful when skiing in flat light.

Fishing

Not only does the filter lens protect the eyes – whether from reflecting sunlight or flying hooks, it can also enhance the visual experience. Many fishing enthusiasts who use filter 527 or 511 combined with Pol 1, enjoy being able to see fish beneath the surface that their fellow anglers next to them can't.

Golf

A round of golf can easily mean several hours of exposure to sunlight. Besides protecting against UV and blue light, the filter lens gives better contrast vision, which is crucial for measuring distance and reading irregularities on the ground. The bright orange Filter 500 combined with a Pol 1 provides very good contrast. If you're looking for a more natural colour perception, you can choose Filter C1.

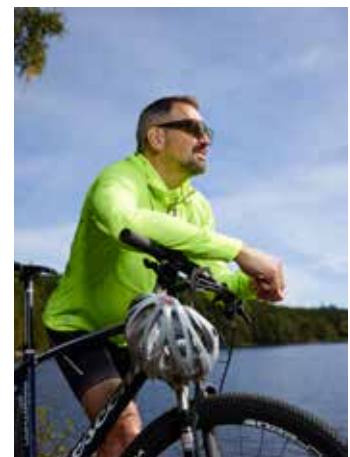

Cycling

Besides providing a solid eye protection the filter lens enhances contrast vision, which allows the cyclist to make quicker decisions. The high level of comfort means fewer problems with squinting and facial tension. For cycling in variable light conditions, both sunlight and shadow, we suggest Filter 500 combined with Pol 1.

ML FILTER IMPROVES EVERYDAY LIFE AND WORK

Computers, iPhones, iPads and TV

The intense blue LED light from computer screens is a relatively new source of light that the eyes are exposed to and causes them to age. Headaches, muscle tension and sleep problems are common side effects after several hours in front of a computer screen. We are also exposed to the harmful blue light when we use smartphones, tablets, computer games and TV. With ML Filter Glasses the blue light is substantially reduced. Suitable filter colour is LLR filter.

Driving in daylight

When we drive in sunlight the eyes are exposed to bright light and disturbing glare from wet asphalt and other flat surfaces. When driving in daylight polarization in combination with an ML Filter should be used. A good combination is ML Filter C1, alternatively ML Filter 450, and Pol 1.

Driving in the dark

If using filter lenses, problems with glare from headlights of oncoming cars can be reduced.

We have developed a special type of filter glasses with unique tint for this problem, called ML Night Cover.



ML FILTER IMPROVES EVERYDAY LIFE AND WORK

Working indoors

Many working environments are very bright, with powerful strip lights and LED lights. With a light filter: LLR, 400 or C1, it's possible to relieve the eyes from the tiresome and harmful exposure of blue light.

Sun protection

It is obviously important to protect the eyes from intensive sunlight when skiing, sunbathing or spending time at the sea. Less obvious is to protect the eyes from sunlight in daily life or when working outdoors. Since people spend more time "in daily life" than in the slope or the beach, it is at least equally important to have correct protection during these activities.

A good choice for these occasions is the ML Filter C1 or 500 combined with Pol 1. If a lot of time is spent in bright light environments, then darker polarization, Pol 3 should be selected. If the contrast vision needs to be improved even more, ML Filter 450 should be used.



AMDCOMFORT

People with AMD (Age related Macula Degeneration) very often have difficulties in getting everyday optics that really help them see significantly better. Normally they are offered standard optics which might help a bit, but an eye with AMD needs more than just the power correction. There are more that could be added. AMD Comfort is a special lens that combines a filter tint with a small magnification. This combination can make a huge different in many people's lives.



	Material	Lins	Layer	Cover 2		Biocover Hazelnut			Biocover Black			Biocover Dark Bronze		
				Hazelnut	Grey	Small	Medium	Large	Small	Medium	Large	Small	Medium	Large
AMD	CR39	AMD-I	-	708016	708017	708033	708034	708035	708001	708002	708003	708013	708014	708015
	CR39	AMD-II	-	708021	708022	708036	708037	708038	708004	708005	708006	708018	708019	708020
	CR39	AMD-I	Pol1	708026	708027	708039	708040	708041	708007	708008	708009	708023	708024	708025
	CR39	AMD-II	Pol1	708031	708032	708042	708043	708044	708010	708011	708012	708028	708029	708030

In the table, all standard products with plano power are listed. AMD Comfort can also be ordered as prescription lenses.

ML FILTER FOR NIGHT DRIVING

Many people experience problems with glare while driving at night. One reason for this problem is the bluish light commonly used in new modern car headlights, typically LED-lights. Another problem that some people experience is reduced visual acuity because of night myopia.

To help these people we have created a solution that addresses these issues. Its main characteristics are:

- It reduces glare created by headlights of oncoming cars. The glare reduction is created by a special filter tint designed to reduce the blue wavelength commonly emitted by LED lights.
- For those that have night myopia, there are versions that includes powers that compensates for this problem. ML Night Cover comes in versions with powers of plano, -0.25 and -0.50
- They include antireflex coating to minimise disturbing reflexes and ghost images.
- ML Night Cover is normally used in a HangOn frame. This makes it possible for the user to keep their normal glasses and only hang on the ML Night Cover during night driving.
- It's also available in our HangOn NP frame, Sun Guard frame, and our flip-ups.

MLNIGHTCOVER



ML FILTER FOR NIGHT DRIVING

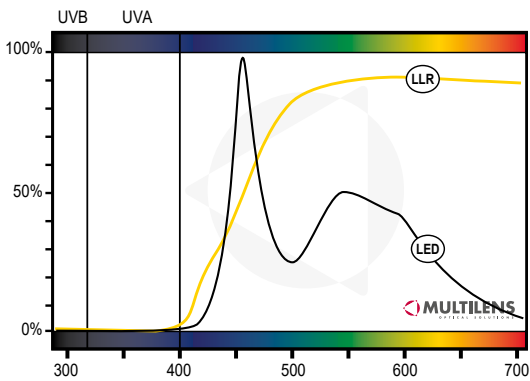

The filter reduces the glaring peak in the wavelength spectrum of LED lights, whilst it is designed to reduce the total amount of light as little as possible. We call the filter ML Filter LLR (LLR = LED Light Reduction). The filter is obviously standard in all our ML Night Covers, but is also possible to tint on our lens program in the same way as our other ML Filters.

Due to technical constraints for high intensity LED-headlights, the typical wavelength curve for these lights looks as above. Our LLR-filter cuts out the peak around 450 nm, which results in less glare and better comfort.

Material	Lens	Power	HangOn	
			HangOn	HangOn NP
CR39	NC-I	Plano	329070	329073
CR39	NC-II	-0.25	329071	329074
CR39	NC-III	-0.50	329072	329081

Material	Lens	Power	Sun Guard 1		Sun Guard 2		Flip-up w/o rim		Flip-up with rim	
			Black	Hazelnut	Black	Hazelnut	Medium	Large	Medium	Large
CR39	NC-I	Plano	329035	329038	329041	329044	329047	329050	329053	329056
CR39	NC-II	-0.25	329036	329039	329042	329045	329048	329051	329054	329057
CR39	NC-III	-0.50	329037	329040	329043	329046	329049	329052	329055	329058

ML BILUX - FOR THE EXTREMELY LIGHT SENSITIVE

For people with high light sensitivity, really dark glasses is not always an ideal solution. Even if they provide comfort, they are sometimes too dark to function in a certain situation! Strong sunlight requires dark glasses, which might be too dark to be able to see, for example, the products in a shopping window. The same applies for filters: For a user, a certain filter might be needed when it is very light and another when it is normal light. Or one filter is more comfortable when looking at a far distance and another filter on short distance. To address this problem, we have invented the ML BILUX Product Family. The idea of ML BILUX products is to use different filters in different parts of the lenses in a pair of glasses. By doing so, the light conditions for certain people can be improved drastically.



Bilux Iris

ML Bilux Iris is designed with a circular section, directly in front of the eye, that is a lighter shade than the rest of the lens. It is usual for the lens to be 97% dark, except for a 10 mm diameter zone right in front of the pupils, where it is 85% dark. The Biocover frame is standard for ML Bilux Iris, but other frames could be used as well.



Bilux Franklin

ML Bilux Franklin is designed so that the upper and lower parts of the lens are different shades. It is typical for the upper section of the lens to be darker (97% dark) than the lower section (85% dark). The line between the two zones is sharp and can be placed at any height.

EXTRA DARK SUNGLASSES

Sometimes, there is a need for darker sunglasses than those available as standard products. We can use a polarized lens and tint it up to a very high absorption. You can also add a filter tint as a base to increase the comfort and contrast.



FILTER LENSES WITH RX FOR LARGE CURVED SPORT FRAMES

When you intend to fit a modern sport frame with RX lenses you face challenges that normally are not present for normal ophthalmic spectacles.

You need a large lens

With decentration of the optical centre we can produce ML Filter lenses with diameters up to 105 mm. This is of course true for Single Vision lenses as well as our freeform progressives. What is less known is that we can also do this with our bifocal lens RS28.

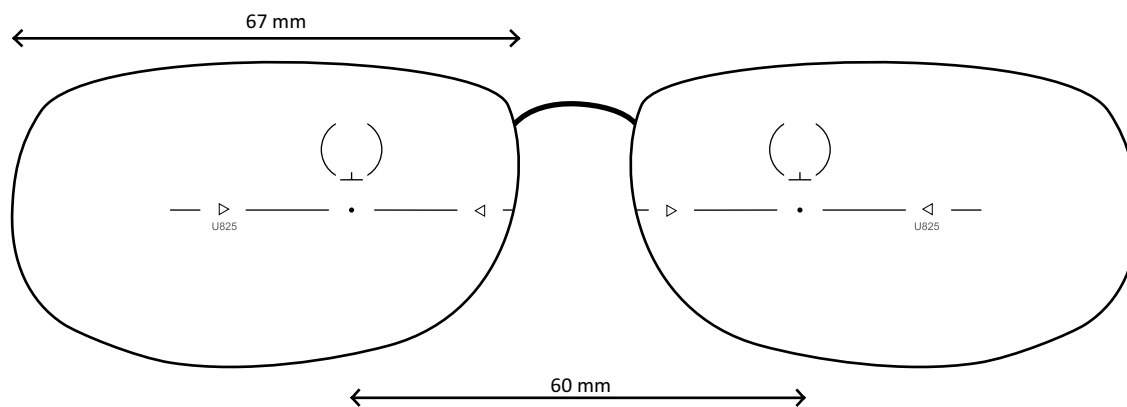

By decentration, we can produce lenses for large frames, even progressives. The above example would need a diameter of 90 mm when measured traditionally.

Curved lens normally means thick lens

A thick lens means added weight and sometimes it needs to be so thick that it can't be produced. Our solution to this is our special grinding techniques Hypersoft and Myosoft. With a slow change in curvature on the backside of the lens, we can produce thinner lenses, allowing for higher powers that otherwise would be impossible. See the illustrations below.

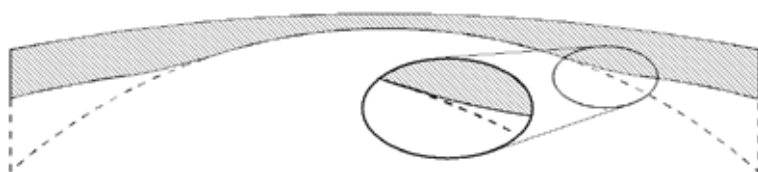

Edge reduction for minus lenses with a soft overlap from optical zone to carrier. The optical zone will be adjusted according to power and frame shape.

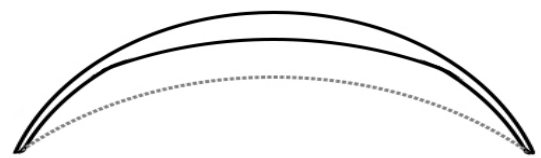

Edge reduction for plus lenses with a soft overlap from optical zone to carrier. The optical zone will be adjusted according to power and frame shape.

The optics need to be adapted to a wrapped frame

Since the sport frames very often are wrapped, the optics need to be adapted accordingly. If no adaptation is made, the wearer will have problems with wrong correction as well as strain due to induced prism effects. Our Perform lenses compensate for these issues (and others) allowing better vision.

Not normal edging - hooks, holes & challenging shapes

Very often sport frames are not only wrapped, but also require hooks and holes in the lens to make it stay. Furthermore, they are designed to hold plano lenses and not RX lenses. When glazing it with RX lenses, you need to adapt the edged form to curves, edges and other details that often exist in these frames. This could be a problem, but Multilens has the latest machinery to handle these challenges.

ML FILTER ON CONTACT LENSES

All ML filters have UV blocking below 400 nm. Note that the filtering of light in soft contact lenses does not give exactly the same filter curve as the edge filter in ophthalmic lens. We are constantly working to improve this, but the transmission curve for ML 511 in contact lenses is not as steep as in glasses.

ML Filter 450 - Clear yellow contact lens that absorbs it short-wave violet light. General contrast enhancement. Absorbs most light below 450 nm.

ML Filter 511 - Absorbs blue light. Comfortable lens for most people. Absorbs most of the light below 511 nm.

ML Filter 527 - In addition to blue light, it also absorbs some of the green light. Can be perceived as too great a color effect for normal vision. Absorbs light below 527 nm

ML Filter 550 - Clear red lens that is mainly used for visually impaired patients eg. with Retinitis Pigmentosa. Absorbs light below 550 nm.

ML Filter 585 - Dark red lens that is usually used at akromatopsier. Absorbs light below 585 nm.

ML Filter colors only Multilens own lenses ML Soft.

Silicone hydrogel cannot be dyed.

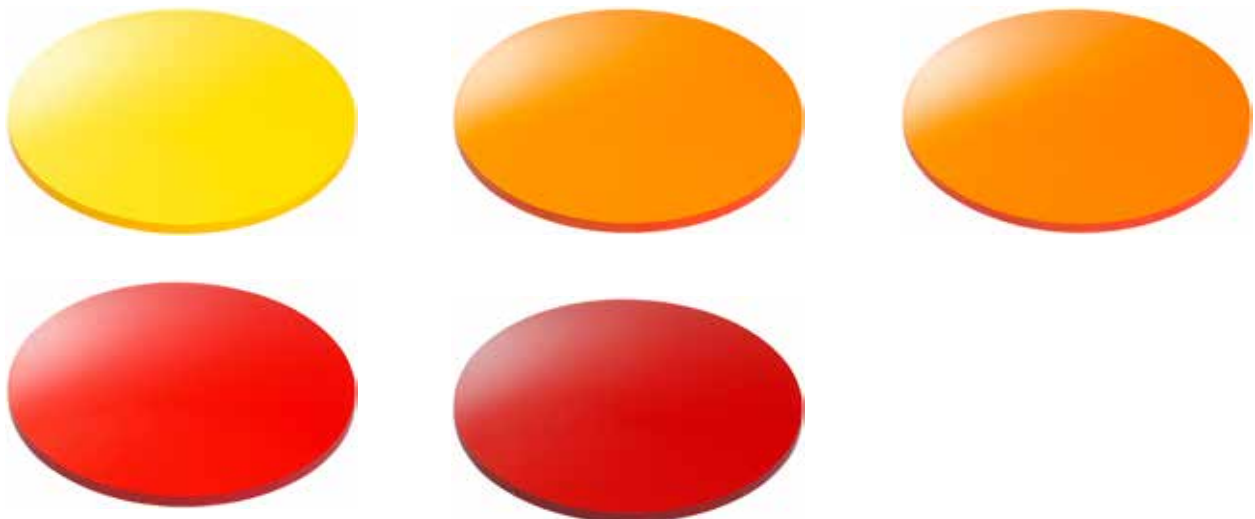

ML Filter was originally developed for medical applications, to increase comfort and visual quality for people with low vision. But filters can also be useful in other situations, for example during work hours and during outdoor activities. For more information and ideas about the practical usage of ML Filter, visit the knowledge section on our website: multilens.com

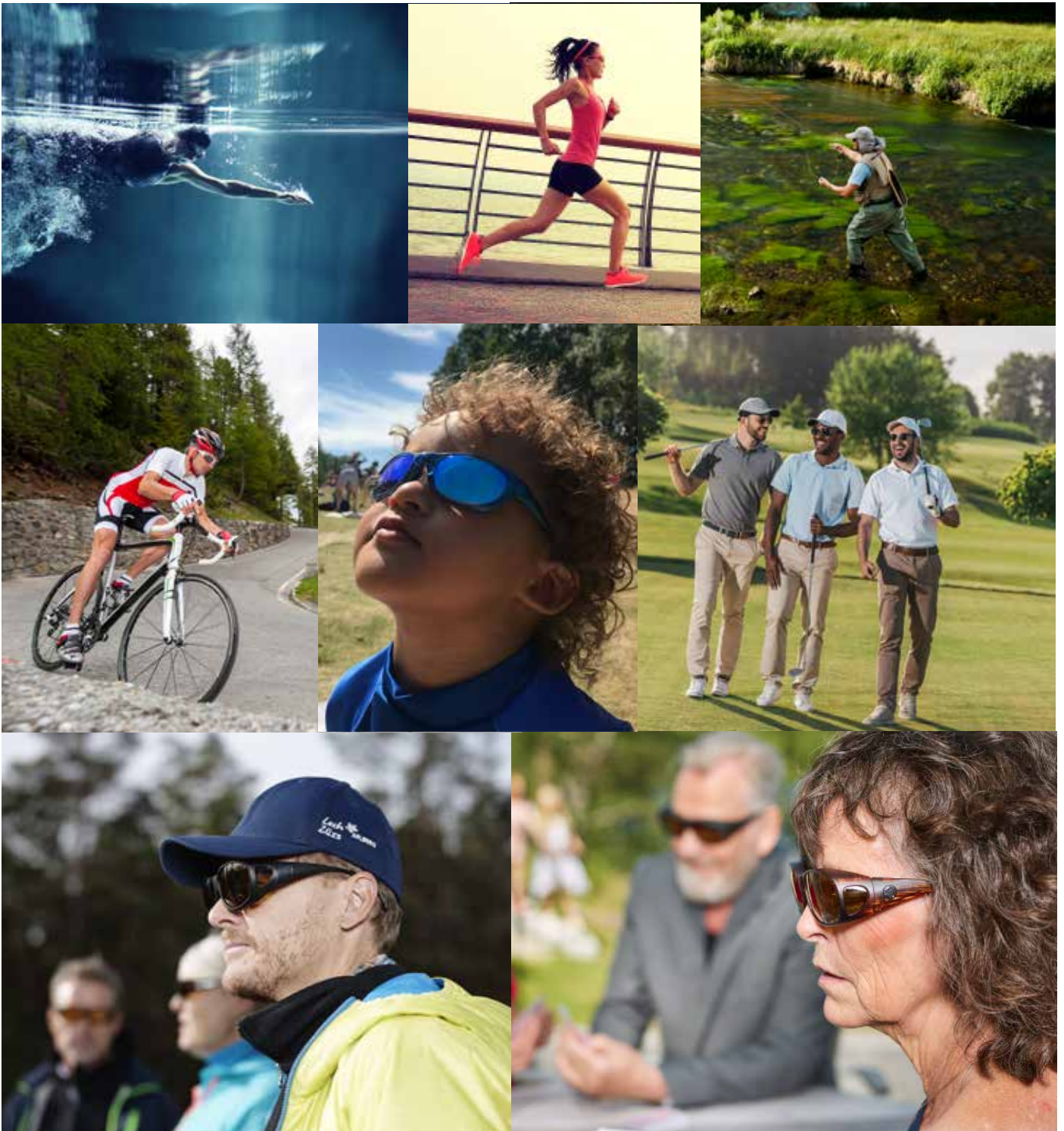

MLFILTER SUNGLASSES



We have a lot of different ready made filter glasses for different needs. On the following pages, there are more information about the available materials and quality levels. You can also find all information about our different frames with plano lenses with ML Filter. Most of the frames are also available with prescription lenses.

ABOUT OUR LENSES

For many years we have been confirmed again and again that even seemingly small improvements in the visual experience can be important. Therefore, we use the coating SunCoat as standard in our ready-made Filter Glasses.

Read more about SunCoat below.

MATERIALS IN OUR LENSES

Index 1.5, CR39

All ML Filters are available with this lens material. The main advantages are its wide range of powers, high optical quality and stable tinting performance.

PC - Polycarbonate

Molded polycarbonate lens with 2.0 mm thickness. Available for most ML Filter and in combination with light or dark polarization. Always includes SunCoat, a backside anti-reflective coating to minimize reflections from behind. The lens main advantages are durability and filter stability. Since the lens is molded, the price is beneficial compared to equivalent CR39 lens. Only available in plano power.

TAC - Triacetate

A pressed 1.0 mm plano lens in Triacetate. The main advantage is its competitive price. Only available in plano power and a few basic tints.

COATINGS

SUNCOAT

SunCoat is a surface treatment that reduce reflection from the back side of the lens. This significantly decreases the disturbing reflections of light coming from your cheeks. The darker the lens is, the more destructive the reflective light can be.

ML PRIMA+

Our well known basic treatment. A very good multicoat including ML Dura, high transmission and the top layer Aqua-coat that reduces the effect of dust and water.

ML PRIMA+ SUN

A treatment designed for sunglasses in CR39. Both front and back surface have the ML Dura treatment for increased scratch resistance. The back side has the ML Prima+ treatment to increase the comfort and to reduce the annoying reflexes on the inside of dark sunglasses.

FILTER CATEGORIES

All sunglasses are attributed to one of five filter categories after how transparent they are. See the table below for the definition of the different categories.

Filter category	Visible light	Absorption	Absorption	Description	Usage
	Transmittance (Tv)	Min-value	Max-value		
0	Tv > 80 %	0 %	< 20 %	Light tint sunglasses	Very limited reduction of sunglare
1	43 % < Tv ≤ 80 %	≥ 20 %	< 57 %	Light tint sunglasses	Limited protection against sunglare
2	18 % < Tv ≤ 43 %	≥ 57 %	< 82 %	General purpose sunglasses	Good protection against sunglare
3	8 % < Tv ≤ 18 %	≥ 82 %	< 92 %	General purpose sunglasses	High protection against sunglare
4	3 % < Tv ≤ 8 %	≥ 92 %	< 97 %	Very dark special purpose sunglasses, very high sunglare reduction	Very high protection against extreme sunglare, e.g. at sea, over snowfields, on high mountains, or in desert

CATEGORIES FOR OUR FILTERS

In the table below, all of our filter lenses are listed with the filter category it belongs to both with and without polarization.

Filter	Category	Transmittance visible light	Night driving Yes/No
LLR	1	79%	Yes
C1	1	79%	Yes
450	1	77%	Yes
500	1	70%	No
511	1	50%	No
527	1	45%	No
550	2	24%	No
585	2	22%	No
450 Pol 1	2	26%	No
C1 Pol 1	2	27%	No
500 Pol 1	2	26%	No
511 Pol 1	2	19%	No
527 Pol 1	3	12%	No
550 Pol 1	3	9%	No
585 Pol 1	4	6%	No
450 Pol 3	3	13%	No
C1 Pol 3	3	14%	No
500 Pol 3	3	13%	No
511 Pol 3	3	8%	No
527 Pol 3	4	7%	No
550 Pol 3	4	4%	No
585 Pol 3	4	3%	No



ABOUT OUR FRAMES

MATERIALS IN OUR FRAMES

Metal

All our metal frames are made of high quality metal and are nickel free.

Acetate

Cellulose acetate, a standard plastic material most plastic frames are made of. Easy to adjust.

TR90 Bio

Our premium plastic material. Flexible, durable and light weight. Made from renewable material which makes this a more environmentally friendly choice. Due to the properties of the material, highest comfort can be achieved without too much adjusting.

SELECTING A FRAME

In general, you should choose a frame that is blocking as much light as possible from the top and from the sides. A wrap-around frame or a frame with sideshields are important to protect yourself from incoming light from the sides. In order to protect from light over and under the frame, it's important that the frame is perfectly aligned with your face or have a protection roof to block unwanted light.

When driving a car, the peripheral vision is highly important so the frame must not block light totally from the sides. If side shields are needed, transparent side shields are preferable.



HORIZON

A frame that celebrates functional design. HorizOn is designed to protect and prevent unwanted sidelight and light from above. The frame is an excellent solution for people who, at home or at work, are disturbed by light from armatures when they are working in front of a screen or staying in an environment illuminated by strip light. For these and similar occasions it is nice to have the ability to prevent the unwanted light.



Model	Specifications
HorizOn	<p>Colour: Grey</p> <p>Size: Hbox: 54 Vbox: 35 Dbl: 19</p> <p>Base: 6</p>



HANGON

A unique frame designed to fit on top most spectacles. The titanium frame makes it light & durable and the flexible temples makes it stable & comfortable for most spectacle wearers.

Model	Specifications
HangOn	<p>Colour: Grey</p> <p>Size: Hbox: 43 Vbox: 35 Dbl: 19</p> <p>Base: 6</p>

ARTICLE NUMBERS FOR HORIZON AND HANGON

VS	Material	Coating	Layer	Filter	HorizOn	HangOn
VS3	PC	MC	-	41	310229	310159
	PC	SunCoat	-	400	310201	310101
	PC	SunCoat	-	C1	310202	310102
	PC	SunCoat	-	450	310203	310103
	PC	SunCoat	-	500	310204	310104
	PC	SunCoat	-	511	310205	310105
	PC	SunCoat	-	527	310206	310106
	PC	SunCoat	-	550	310207	310107
	PC	SunCoat	-	585	310208	310108
	PC	SunCoat	POL 1	UV	310210	310110
	PC	SunCoat	POL 1	400	310211	310111
	PC	SunCoat	POL 1	C1	310212	310112
	PC	SunCoat	POL 1	450	310213	310113
	PC	SunCoat	POL 1	500	310214	310114
	PC	SunCoat	POL 1	511	310215	310115
	PC	SunCoat	POL 1	527	310216	310116
	PC	SunCoat	POL 1	550	310217	310117
	PC	SunCoat	POL 1	585	310218	310118
	PC	SunCoat	POL 3	UV	310220	310120
	PC	SunCoat	POL 3	400	310221	310121
	PC	SunCoat	POL 3	C1	310222	310122
	PC	SunCoat	POL 3	450	310223	310123
	PC	SunCoat	POL 3	500	310224	310124
	PC	SunCoat	POL 3	511	310225	310125
	PC	SunCoat	POL 3	527	310226	310126
	PC	SunCoat	POL 3	550	310227	310127
	CR39	PrimaSun	POL 3	585	310228	310128

ML Filter Photocromatic

VS	Material	Coating	Layer	Filter	HorizOn	HangOn
VS3	PC	SunCoat	Photoc.	C1	310230	-
	PC	SunCoat	Photoc.	450	310231	-
	PC	SunCoat	Photoc.	500	310232	-
	PC	SunCoat	Photoc.	511	310233	-

ML Filter Bifocals with Add +2.5

VS	Material	Coating	Layer	Filter	HorizOn	HangOn
VS3	PC	SunCoat	POL 1	C1	330008	330000
	PC	SunCoat	POL 1	450	330009	330001
	PC	SunCoat	POL 1	500	330010	330002
	PC	SunCoat	POL 1	511	330011	330003

Of course, it's possible to get the frames with other lenses (i.e. RX lenses), see our catalogue Optics, Special optics and frames.

BIOCOVER

Biocover is designed to be used together with a normal pair of glasses. The frame is made of renewable raw material. The side lens has the same tint as the front lenses.



Model	Specifications
Biocover S Hazelnut	Colour: Speckled Brown Size: Hbox: 60 Vbox: 40 Dbl: 12 Front width: ~13 cm Base: 6
Biocover M Hazelnut	Colour: Speckled Brown Size: Hbox: 64 Vbox: 42 Dbl: 13 Front width: ~14,2 cm Base: 6
Biocover L Hazelnut	Colour: Speckled Brown Size: Hbox: 67 Vbox: 46 Dbl: 15 Front width: ~14,8 cm Base: 6
Biocover S Black	Colour: Black Size: Hbox: 60 Vbox: 40 Dbl: 12 Front width: ~13 cm Base: 6
Biocover M Black	Colour: Black Size: Hbox: 64 Vbox: 42 Dbl: 13 Front width: ~14,2 cm Base: 6
Biocover L Black	Colour: Black Size: Hbox: 67 Vbox: 46 Dbl: 15 Front width: ~14,8 cm Base: 6
Biocover S Dark Bronze	Colour: Dark Bronze Size: Hbox: 60 Vbox: 40 Dbl: 12 Front width: ~13 cm Base: 6
Biocover M Dark Bronze	Colour: Dark Bronze Size: Hbox: 64 Vbox: 42 Dbl: 13 Front width: ~14,2 cm Base: 6
Biocover L Dark Bronze	Colour: Dark Bronze Size: Hbox: 67 Vbox: 46 Dbl: 15 Front width: ~14,8 cm Base: 6



ARTICLE NUMBERS FOR BIOCOVER

VS	Material	Coating	Layer	Filter	Biocover Hazelnut			Biocover Black			Biocover Dark Bronze		
					Small	Medium	Large	Small	Medium	Large	Small	Medium	Large
VS1	TAC	-	POL B	UV	315100	315150	315200	311101	312101	313101	316101	317101	318101
	TAC	-	POL G	UV	315101	315151	315201	311102	312102	313102	316102	317102	318102
	TAC	-	POL Y2	UV	315102	315152	315202	311104	312104	313104	316104	317104	318104
VS3	PC	MC	-	41	318139	318140	318141	318142	318143	318144	318145	318146	318147
	PC	SunCoat	-	400	315240	315250	315260	311130	312130	313130	316130	317130	318130
	PC	SunCoat	-	C1	315241	315251	315261	311131	312131	313131	316131	317131	318131
	PC	SunCoat	-	450	315242	315252	315262	311132	312132	313132	316132	317132	318132
	PC	SunCoat	-	500	315243	315253	315263	311133	312133	313133	316133	317133	318133
	PC	SunCoat	-	511	315244	315254	315264	311134	312134	313134	316134	317134	318134
	PC	SunCoat	-	527	315245	315255	315265	311135	312135	313135	316135	317135	318135
	PC	SunCoat	-	550	315246	315256	315266	311136	312136	313136	316136	317136	318136
	PC	SunCoat	-	585	315247	315257	315267	311137	312137	313137	316137	317137	318137
	PC	SunCoat	POL 1	UV	315119	315169	315219	311000	312000	313000	316000	317000	318000
	PC	SunCoat	POL 1	400	315120	315170	315220	311110	312110	313110	316110	317110	318110
	PC	SunCoat	POL 1	C1	315121	315171	315221	311111	312111	313111	316111	317111	318111
	PC	SunCoat	POL 1	450	315122	315172	315222	311112	312112	313112	316112	317112	318112
	PC	SunCoat	POL 1	500	315123	315173	315223	311113	312113	313113	316113	317113	318113
	PC	SunCoat	POL 1	511	315124	315174	315224	311114	312114	313114	316114	317114	318114
	PC	SunCoat	POL 1	527	315125	315175	315225	311115	312115	313115	316115	317115	318115
	PC	SunCoat	POL 1	550	315126	315176	315226	311116	312116	313116	316116	317116	318116
	PC	SunCoat	POL 1	585	315127	315177	315227	311117	312117	313117	316117	317117	318117
	PC	SunCoat	POL 3	UV	315128	315178	315228	311200	312200	313200	316200	317200	318200
	PC	SunCoat	POL 3	400	315129	315179	315229	311120	312120	313120	316120	317120	318120
	PC	SunCoat	POL 3	C1	315130	315180	315230	311121	312121	313121	316121	317121	318121
	PC	SunCoat	POL 3	450	315131	315181	315231	311122	312122	313122	316122	317122	318122
	PC	SunCoat	POL 3	500	315132	315182	315232	311123	312123	313123	316123	317123	318123
	PC	SunCoat	POL 3	511	315133	315183	315233	311124	312124	313124	316124	317124	318124
	PC	SunCoat	POL 3	527	315134	315184	315234	311125	312125	313125	316125	317125	318125
	PC	SunCoat	POL 3	550	315135	315185	315235	311126	312126	313126	316126	317126	318126
	CR39	PrimaSun	POL 3	585	315136	315186	315236	311127	312127	313127	316127	317127	318127

ML Filter Photocromatic

VS	Material	Coating	Layer	Filter	Small	Medium	Large	Small	Medium	Large	Small	Medium	Large
VS3	PC	SunCoat	Photoc.	C1	315137	315187	315214	311139	312138	313138	316138	317138	317996
	PC	SunCoat	Photoc.	450	315138	315188	315237	311128	312128	313128	316139	317139	317997
	PC	SunCoat	Photoc.	500	315139	315189	315238	311140	312139	313139	316140	317140	317998
	PC	SunCoat	Photoc.	511	315140	315190	315239	311141	312140	313140	316141	317141	317999

ML Filter Bifocals with Add +2.5

VS	Material	Coating	Layer	Filter	Small	Medium	Large	Small	Medium	Large	Small	Medium	Large
VS3	PC	SunCoat	POL 1	C1	330012	330016	330020	330024	330028	330032	330036	330040	330044
	PC	SunCoat	POL 1	450	330013	330017	330021	330025	330029	330033	330037	330041	330045
	PC	SunCoat	POL 1	500	330014	330018	330022	330026	330030	330034	330038	330042	330046
	PC	SunCoat	POL 1	511	330015	330019	330023	330027	330031	330035	330039	330043	330047

Of course, it's possible to get the frames with other lenses (i.e. RX lenses), see our catalogue Optics & Special optics. Items with blue background are stock items and will normally be delivered within one day.

COVER 2

Cover 2 is designed to be used over a normal pair of glasses. Compared to Biocover, the frame has a more straight design. The frame is made of renewable material. Side lenses has the same tint as the front lenses.

Model	Specifications
Cover 2 Brown	Colour: Speckled Brown Size: Hbox: 61 Vbox: 42 Dbl: 14 Front width: ~16,5 cm Base: 6
Cover 2 Grey	Colour: Semi transparent Grey Size: Hbox: 61 Vbox: 42 Dbl: 14 Front width: ~16,5 cm Base: 6



COVER KID

Cover Kid is a smaller cover frame designed to be used together with a normal pair of glasses. The perfect cover frame for children. The frame is made of high quality material.

Model	Specifications
Cover Kid Blue	Colour: Black front, blue temples Size: Hbox: 55 Vbox: 35 Dbl: 12 Base: 6
Cover Kid Red	Colour: Black front, red temples Size: Hbox: 55 Vbox: 35 Dbl: 12 Base: 6
Cover Kid Black	Colour: Black front, black temples Size: Hbox: 55 Vbox: 35 Dbl: 12 Base: 6

ARTICLE NUMBERS FOR COVER 2 AND COVER KID

VS	Material	Coating	Layer	Filter	Cover 2		Cover Kid		
					Hazelnut	Grey	Navy	Red	Black
VS1	TAC	-	POL B	UV	318301	318335	326101	327101	328101
	TAC	-	POL G	UV	318302	318336	326102	327102	328102
	TAC	-	POL Y2	UV	318303	318337	326104	327104	328104
VS3	PC	MC	-	41	318422	418423	318424	318425	318426
	PC	SunCoat	-	400	318404	318412	326073	327073	328073
	PC	SunCoat	-	C1	318405	318413	326074	327074	328074
	PC	SunCoat	-	450	318406	318414	326075	327075	328075
	PC	SunCoat	-	500	318407	318415	326076	327076	328076
	PC	SunCoat	-	511	318408	318416	326077	327077	328077
	PC	SunCoat	-	527	318409	318417	326078	327078	328078
	PC	SunCoat	-	550	318410	318418	326079	327079	328079
	PC	SunCoat	-	585	318411	318419	326080	327080	328080
	PC	SunCoat	POL 1	UV	318368	318386	326081	327081	328081
	PC	SunCoat	POL 1	400	318369	318387	326082	327082	328082
	PC	SunCoat	POL 1	C1	318370	318388	326083	327083	328083
	PC	SunCoat	POL 1	450	318371	318389	326084	327084	328084
	PC	SunCoat	POL 1	500	318372	318390	326085	327085	328085
	PC	SunCoat	POL 1	511	318373	318391	326086	327086	328086
	PC	SunCoat	POL 1	527	318374	318392	326087	327087	328087
	PC	SunCoat	POL 1	550	318375	318393	326088	327088	328088
	PC	SunCoat	POL 1	585	318376	318394	326089	327089	328089
	PC	SunCoat	POL 3	UV	318377	318395	326090	327090	328090
	PC	SunCoat	POL 3	400	318378	318396	326091	327091	328091
	PC	SunCoat	POL 3	C1	318379	318397	326092	327092	328092
	PC	SunCoat	POL 3	450	318380	318398	326093	327093	328093
	PC	SunCoat	POL 3	500	318381	318399	326094	327094	328094
	PC	SunCoat	POL 3	511	318382	318400	326095	327095	328095
	PC	SunCoat	POL 3	527	318383	318401	326096	327096	328096
	PC	SunCoat	POL 3	550	318384	318402	326097	327097	328097
	CR39	PrimaSun	POL 3	585	318385	318403	326098	327098	328098

ML Filter Photocromatic

VS	Material	Coating	Layer	Filter	Hazelnut	Grey	Navy	Red	Black
VS3	PC	SunCoat	Photoc.	C1	318338	318342	326011	327016	328009
	PC	SunCoat	Photoc.	450	318339	318343	326012	327017	328010
	PC	SunCoat	Photoc.	500	318340	318344	326013	327018	328011
	PC	SunCoat	Photoc.	511	318341	318345	326014	327019	328012

ML Filter Bifocals with Add +2.5

VS	Material	Coating	Layer	Filter	Hazelnut	Grey	Navy	Red	Black
VS3	PC	SunCoat	POL 1	C1	330048	330052	-	-	-
	PC	SunCoat	POL 1	450	330049	330053	-	-	-
	PC	SunCoat	POL 1	500	330050	330054	-	-	-
	PC	SunCoat	POL 1	511	330051	330055	-	-	-

Of course, it's possible to get the frames with other lenses (i.e. RX lenses), see our catalogue Optics, Special optics and frames. Items with blue background are stock items and will normally be delivered within one day.

SUN GUARD

Provides excellent protection from light coming from the sides and from above. The Sun Guard frames are made of TR90 material with side lenses corresponding to the filter lens. Side lenses in the same colour as the frame are also available (sold separately).

Rubber temple tips for a good fit.

Model	Specifications
Sun Guard 1 Black	Colour: Black Size: Hbox: 57 Vbox: 38 Dbl: 15 Base: 6
Sun Guard 2 Black	Colour: Black Size: Hbox: 60 Vbox: 42 Dbl: 14 Base: 6
Sun Guard 1 Hazelunt	Colour: Speckled Brown Size: Hbox: 57 Vbox: 38 Dbl: 15 Base: 6
Sun Guard 2 Hazelunt	Colour: Speckled Brown Size: Hbox: 60 Vbox: 42 Dbl: 14 Base: 6



ARTICLE NUMBERS FOR SUN GUARD

VS	Material	Coat	Layer	Filter	Sun Guard 1		Sun Guard 2	
					Black	HazelNut	Black	HazelNut
VS3	PC	MC	-	41	325586	325587	325588	325589
	PC	SunCoat	-	400	325440	325480	325520	325560
	PC	SunCoat	-	C1	325441	325481	325521	325561
	PC	SunCoat	-	450	325442	325482	325522	325562
	PC	SunCoat	-	500	325443	325483	325523	325563
	PC	SunCoat	-	511	325444	325484	325524	325564
	PC	SunCoat	-	527	325445	325485	325525	325565
	PC	SunCoat	-	550	325446	325486	325526	325566
	PC	SunCoat	-	585	325447	325487	325527	325567
	PC	SunCoat	POL 1	UV	325448	325488	325528	325568
	PC	SunCoat	POL 1	400	325449	325489	325529	325569
	PC	SunCoat	POL 1	C1	325450	325490	325530	325570
	PC	SunCoat	POL 1	450	325451	325491	325531	325571
	PC	SunCoat	POL 1	500	325452	325492	325532	325572
	PC	SunCoat	POL 1	511	325453	325493	325533	325573
	PC	SunCoat	POL 1	527	325454	325494	325534	325574
	PC	SunCoat	POL 1	550	325455	325495	325535	325575
	PC	SunCoat	POL 1	585	325456	325496	325536	325576
	PC	SunCoat	POL 3	UV	325457	325497	325537	325577
	PC	SunCoat	POL 3	400	325458	325498	325538	325578
	PC	SunCoat	POL 3	C1	325459	325499	325539	325579
	PC	SunCoat	POL 3	450	325460	325500	325540	325580
	PC	SunCoat	POL 3	500	325461	325501	325541	325581
	PC	SunCoat	POL 3	511	325462	325502	325542	325582
	PC	SunCoat	POL 3	527	325463	325503	325543	325583
	PC	SunCoat	POL 3	550	325464	325504	325544	325584
	CR39	PrimaSun	POL 3	585	325465	325505	325545	325585

ML Filter Photocromatic

VS	Material	Coating	Layer	Filter	Black	HazelNut	Black	HazelNut
VS3	PC	SunCoat	Photoc.	C1	325466	325476	325516	325556
	PC	SunCoat	Photoc.	450	325467	325477	325517	325557
	PC	SunCoat	Photoc.	500	325468	325478	325518	325558
	PC	SunCoat	Photoc.	511	325469	325479	325519	325559

ML Filter Bifocals with Add +2.5

VS	Material	Coating	Layer	Filter	Black	HazelNut	Black	HazelNut
VS3	PC	SunCoat	POL 1	C1	330056	330060	330064	330068
	PC	SunCoat	POL 1	450	330057	330061	330065	330069
	PC	SunCoat	POL 1	500	330058	330062	330066	330070
	PC	SunCoat	POL 1	511	330059	330063	330067	330071

Of course, it's possible to get the frames with other lenses (i.e. RX lenses), see our catalogue Optics, Special optics and frames. Items with blue background are stock items and will normally be delivered within one day.

SUN LADY

With large lenses which provides a large field of view. It is designed to have a tight fit on most people.

Model	Specifications
Sun Lady	Colour: Dark Bronze Size: Hbox: 64 Vbox: 38 Dbl: 18 Base: 8



SUN LADY 2

A smaller version of its popular big sister Sun Lady, with a tight fit on most people.

Model	Specifications
Sun Lady 2	Colour: Speckled Brown Size: Hbox: 56 Vbox: 40 Dbl: 19 Base: 6

SUN V

A plastic frame that protects well against light from the sides. A frame with a tight and comfortable fit.

Model	Specifications
Sun V	Colour: Maroon (Red-Brown) Size: Hbox: 66 Vbox: 41 Dbl: 16 Base: 8



SUN 6

A fram with an exclusive look and high quality. Made of acetate and metal free of nickel.

Model	Specifications
Sun 6	Colour: Black Size: Hbox: 57 Vbox: 36 Dbl: 19 Base: 6

SUN 7

An elegant black frame with good light protection from the sides. It's made of TR90 and the inside of the temples have a rubber layer for a better fit.

Model	Specifications
Sun 7	Colour: Black Size: Hbox: 63 Vbox: 39 Dbl: 16 Base: 6



SUN 2

A small frame with a really good fit, designed for sports and an active lifestyle. The inside of the temples have rubber temple tips for a better fit.



Model	Specifications
Sun 2 Grey	Colour: Transparent Grey Size: Hbox: 56 Vbox: 37 Dbl: 22 Base: 6
Sun 2 Brown	Colour: Speckled Brown Size: Hbox: 56 Vbox: 37 Dbl: 22 Base: 6

ARTICLE NUMBERS FOR SUN LADY, SUN LADY 2, SUN V, SUN 6, SUN 7 AND SUN 2

VS	Material	Coating	Layer	Filter	Sun Lady	Sun Lady 2	Sun V	Sun 6	Sun 7	Sun 2	
										Grey	Brown
VS3	PC	MC	-	41	-	314066	-	324415	325067	39175	39176
	PC ¹	SunCoat	-	400	314042*	314142	319042*	324038	325038	39138	39038
	PC	SunCoat	-	C1	314043	314143	319043	324039	325039	39139	39039
	PC	SunCoat	-	450	314044	314144	319044	324040	325040	39140	39040
	PC	SunCoat	-	500	314045	314145	319045	324041	325041	39141	39041
	PC	SunCoat	-	511	314046	314146	319046	324042	325042	39142	39042
	PC	SunCoat	-	527	314047	314147	319047	324043	325043	39143	39043
	PC	SunCoat	-	550	314048	314148	319048	324044	325044	39144	39044
	PC ¹	SunCoat	-	585	314049*	314149	319049*	324045	325045	39145	39045
	PC ¹	SunCoat	POL 1	UV	314056*	314150	319056*	324056	325056	39156	39056
	PC ¹	SunCoat	POL 1	400	314057*	314151	319057*	324057	325057	39157	39057
	PC	SunCoat	POL 1	C1	314038	314152	319038	324407	325001	39158	39058
	PC	SunCoat	POL 1	450	314039	314153	319039	324408	325002	39159	39059
	PC	SunCoat	POL 1	500	314040	314154	319040	324409	325003	39160	39060
	PC	SunCoat	POL 1	511	314041	314155	319041	324410	325004	39161	39061
	PC	SunCoat	POL 1	527	314058	314156	319058	324058	325058	39162	39062
	PC ¹	SunCoat	POL 1	550	314059*	314157	319059*	324059	325059	39163	39063
	PC ¹	SunCoat	POL 1	585	314060*	314158	319060*	324060	325060	39164	39064
	PC ¹	SunCoat	POL 3	UV	314061*	314159	319061*	324061	325061	39165	39065
	PC ¹	SunCoat	POL 3	400	314062*	314160	319062*	324062	325062	39166	39066
	PC	SunCoat	POL 3	C1	314412	314161	319063	324411	325005	39167	39067
	PC	SunCoat	POL 3	450	314413	314162	319064	324412	325006	39168	39068
	PC	SunCoat	POL 3	500	314414	314163	319065	324413	325008	39169	39069
	PC	SunCoat	POL 3	511	314415	314164	319066	324414	325009	39170	39070
	PC	SunCoat	POL 3	527	314063	314165	319067	324063	325063	39171	39071
	PC ¹	SunCoat	POL 3	550	314064*	314166	319068*	324064	325064	39172	39072
	CR39	PrimaSun	POL 3	585	314065	314167	319069	324065	325065	39173	39073

1=Articles marked with * has lenses made of CR39, coated with Prima Sun

VS	Material	Coating	Layer	Filter	Sun Lady	Sun Lady 2	Sun V	Sun 6	Sun 7	Sun 2	
VS	PC	MIRA	POL 1	C1	314008	-	-	324008	325000	-	-

ML Filter Photocromatic

VS	Material	Coating	Layer	Filter	Sun Lady	Sun Lady 2	Sun V	Sun 6	Sun 7	Sun 2	
										Grey	Brown
VS3	PC	SunCoat	Photoc.	C1	-	314067	-	324003	325068	39177	39046
	PC	SunCoat	Photoc.	450	-	314068	-	324004	325069	39178	39047
	PC	SunCoat	Photoc.	500	-	314069	-	324005	325070	39179	39048
	PC	SunCoat	Photoc.	511	-	314070	-	324006	325071	39180	39049

ML Filter Bifocals with Add +2.5

VS	Material	Coating	Layer	Filter	Sun Lady	Sun Lady 2	Sun V	Sun 6	Sun 7	Sun 2	
										Grey	Brown
VS3	PC	SunCoat	POL 1	C1	-	330076	-	330084	330088	330092	330096
	PC	SunCoat	POL 1	450	-	314168	-	324066	325066	39174	39074
	PC	SunCoat	POL 1	500	-	330078	-	330086	330090	330093	330097
	PC	SunCoat	POL 1	511	-	330079	-	330087	330091	330094	330098

Of course, it's possible to get the frames with other lenses (i.e. RX lenses), see our catalogue Optics & Special optics. Items with blue background are stock items and will normally be delivered within one day.

SUN 3

Designed to protect from light coming from the sides and is therefore suitable for sensitive people. A plastic frame with rubber temple tops and a metal core allowing a precise individual adjustment.

Model	Specifications
Sun 3 Brown S	Colour: Speckled Brown Size: Hbox: 47 Vbox: 30 Dbl: 16 Base: 6
Sun 3 Brown M	Colour: Speckled Brown Size: Hbox: 50 Vbox: 34 Dbl: 15 Base: 6
Sun 3 Brown L	Colour: Speckled Brown Size: Hbox: 55 Vbox: 34 Dbl: 15 Base: 6
Sun 3 Black M	Colour: Black Size: Hbox: 50 Vbox: 34 Dbl: 15 Base: 6
Sun 3 Black L	Colour: Black Size: Hbox: 55 Vbox: 34 Dbl: 15 Base: 6
Sun 3 Black XL	Colour: Black Size: Hbox: 59 Vbox: 38 Dbl: 16 Base: 6



ARTICLE NUMBERS FOR SUN 3

VS	Material	Coating	Layer	Filter	Sun 3 Brown			Sun 3 Black		
					S	M	L	M	L	XL
VS3	PC	MC	-	41	329774	329775	329776	329777	329778	329779
	PC	SunCoat	-	400	39238	39338	39438	39738	39538	39638
	PC	SunCoat	-	C1	39239	39339	39439	39739	39539	39639
	PC	SunCoat	-	450	39240	39340	39440	39740	39540	39640
	PC	SunCoat	-	500	39241	39341	39441	39741	39541	39641
	PC	SunCoat	-	511	39242	39342	39442	39742	39542	39642
	PC	SunCoat	-	527	39243	39343	39443	39743	39543	39643
	PC	SunCoat	-	550	39244	39344	39444	39744	39544	39644
	PC	SunCoat	-	585	39245	39345	39445	39745	39545	39645
	PC	SunCoat	POL 1	UV	39256	39356	39456	39756	39556	39656
	PC	SunCoat	POL 1	400	39257	39357	39457	39757	39557	39657
	PC	SunCoat	POL 1	C1	39258	39358	39458	39758	39558	39658
	PC	SunCoat	POL 1	450	39259	39359	39459	39759	39559	39659
	PC	SunCoat	POL 1	500	39260	39360	39460	39760	39560	39660
	PC	SunCoat	POL 1	511	39261	39361	39461	39761	39561	39661
	PC	SunCoat	POL 1	527	39262	39362	39462	39762	39562	39662
	PC	SunCoat	POL 1	550	39263	39363	39463	39763	39563	39663
	PC	SunCoat	POL 1	585	39264	39364	39464	39764	39564	39664
	PC	SunCoat	POL 3	UV	39265	39365	39465	39765	39565	39665
	PC	SunCoat	POL 3	400	39266	39366	39466	39766	39566	39666
	PC	SunCoat	POL 3	C1	39267	39367	39467	39767	39567	39667
	PC	SunCoat	POL 3	450	39268	39368	39468	39768	39568	39668
	PC	SunCoat	POL 3	500	39269	39369	39469	39769	39569	39669
	PC	SunCoat	POL 3	511	39270	39370	39470	39770	39570	39670
	PC	SunCoat	POL 3	527	39271	39371	39471	39771	39571	39671
	PC	SunCoat	POL 3	550	39272	39372	39472	39772	39572	39672
	CR39	PrimaSun	POL 3	585	39273	39373	39473	39773	39573	39673

ML Filter Photocromatic

VS	Material	Coating	Layer	Filter	S	M	L	M	L	XL
VS3	PC	SunCoat	Photoc.	C1	39274	39374	39474	39774	39574	39674
	PC	SunCoat	Photoc.	450	39275	39375	39475	39775	39575	39675
	PC	SunCoat	Photoc.	500	39276	39376	39476	39776	39576	39676
	PC	SunCoat	Photoc.	511	39277	39377	39477	39777	39577	39677

ML Filter Bifocals with Add +2.5

VS	Material	Coating	Layer	Filter	S	M	L	M	L	XL
VS3	PC	SunCoat	POL 1	C1	330100	330104	330108	330112	330116	330120
	PC	SunCoat	POL 1	450	330101	330105	330109	330113	330117	330121
	PC	SunCoat	POL 1	500	330102	330106	330110	330114	330118	330122
	PC	SunCoat	POL 1	511	330103	330107	330111	330115	330119	330123

Of course, it's possible to get the frames with other lenses (i.e. RX lenses), see our catalogue Optics, Special optics and frames.

FLIP-UP

Clip-on that allows you to quickly switch between optics with filter to optics without filter. The design makes it possible to attach the clip-on to most frames. It can simply be attached to a pair of glasses with a handgrip. Its available with & without rim. The Clip-on mechanism is made of metal and the front of the clip-on with rim is made of acetate.



Model	Specifications
Flip-up with rim Madium	Colour: Beige Size: Hbox: 51 Vbox: 37 Dbl: 19 Base: 6
Flip-up with rim Large	Colour: Beige Size: Hbox: 51 Vbox: 44 Dbl: 19 Base: 6
Flip-up without rim Madium	Colour: - Size: Hbox: 54 Vbox: 43 Dbl: 14 Base: 6
Flip-up without rim Large	Colour: - Size: Hbox: 57 Vbox: 48 Dbl: 14 Base: 6

ALEX

A frame that Multilens has had in its line-up for a long time. Persistence has now given fruit, and the frame is once again in line with the fashion.

Model	Specifications
Alex Brown	Colour: Transparent Brown Size: Hbox: 49 Vbox: 41 Dbl: 19 Base: 6
Alex Black	Colour: Black Size: Hbox: 49 Vbox: 41 Dbl: 19 Base: 6



NELLI

A classic Multilens frame that has been around for many generations, especially with our Filter lenses ML450 and ML511. Now the time has given it a boost again, especially for those interested in fashion, but then with filter lenses that also include polarization.

Model	Specifications
Nelli Brown	Colour: Speckled Brown Size: Hbox: 50 Vbox: 41 Dbl: 18 Base: 6
Nelli Black	Colour: Black Size: Hbox: 50 Vbox: 41 Dbl: 18 Base: 6

ARTICLE NUMBERS FOR FLIP-UP, ALEX AND NELLI

VS	Material	Coating	Layer	Filter	Flip-Up w/o		Flip-Up with		Alex		Nelli	
					Medium	Large	Medium	Large	Brown	Black	Brown	Black
VS3	PC	MC	-	41	32553	32554	33555	33556	35483	35484	36383	36384
	PC	SunCoat	-	400	32256	322256	33256	323256	35256	35456	36256	36356
	PC	SunCoat	-	C1	32257	322257	33257	323257	35257	35457	36257	36357
	PC	SunCoat	-	450	32258	322258	33258	323258	35258	35458	36258	36358
	PC	SunCoat	-	500	32259	322259	33259	323259	35259	35459	36259	36359
	PC	SunCoat	-	511	32260	322260	33260	323260	35260	35460	36260	36360
	PC	SunCoat	-	527	32261	322261	33261	323261	35261	35461	36261	36361
	PC	SunCoat	-	550	32262	322262	33262	323262	35262	35462	36262	36362
	PC	SunCoat	-	585	32263	322263	33263	323263	35263	35463	36263	36363
	PC	SunCoat	POL 1	UV	32264	322264	33264	323264	35264	35464	36264	36364
	PC	SunCoat	POL 1	400	32265	322265	33265	323265	35265	35465	36265	36365
	PC	SunCoat	POL 1	C1	32266	322266	33266	323266	35266	35466	36266	36366
	PC	SunCoat	POL 1	450	32267	322267	33267	323267	35267	35467	36267	36367
	PC	SunCoat	POL 1	500	32268	322268	33268	323268	35268	35468	36268	36368
	PC	SunCoat	POL 1	511	32269	322269	33269	323269	35269	35469	36269	36369
	PC	SunCoat	POL 1	527	32270	322270	33270	323270	35270	35470	36270	36370
	PC	SunCoat	POL 1	550	32271	322271	33271	323271	35271	35471	36271	36371
	PC	SunCoat	POL 1	585	32272	322272	33272	323272	35272	35472	36272	36372
	PC	SunCoat	POL 3	UV	32273	322273	33273	323273	35273	35473	36273	36373
	PC	SunCoat	POL 3	400	32274	322274	33274	323274	35274	35474	36274	36374
	PC	SunCoat	POL 3	C1	32275	322275	33275	323275	35275	35475	36275	36375
	PC	SunCoat	POL 3	450	32276	322276	33276	323276	35276	35476	36276	36376
	PC	SunCoat	POL 3	500	32277	322277	33277	323277	35277	35477	36277	36377
	PC	SunCoat	POL 3	511	32278	322278	33278	323278	35278	35478	36278	36378
	PC	SunCoat	POL 3	527	32279	322279	33279	323279	35279	35479	36279	36379
	PC	SunCoat	POL 3	550	32280	322280	33280	323280	35280	35480	36280	36380
	CR39	PrimaSun	POL 3	585	32281	322281	33281	323281	35281	35481	36281	36381

ML Filter Photocromatic

VS	Material	Coating	Layer	Filter	Medium	Large	Medium	Large	Brown	Black	Brown	Black
VS3	PC	SunCoat	Photoc.	C1	32555	322282	33557	323553	35242	35485	36284	36385
VS3	PC	SunCoat	Photoc.	450	32556	322283	33558	323554	35243	35486	36285	36386
VS3	PC	SunCoat	Photoc.	500	32557	322284	33559	323555	35244	35487	36286	36387
VS3	PC	SunCoat	Photoc.	511	32558	322285	33560	323556	35245	35488	36287	36388

ML Filter Bifocals with Add +2.5

VS	Material	Coating	Layer	Filter	Brown	Black	Brown	Black	Brown	Black	Brown	Black
VS3	PC	SunCoat	POL 1	C1	-	-	-	-	330124	330128	330132	330136
VS3	PC	SunCoat	POL 1	450	-	-	-	-	35282	35482	36282	36382
VS3	PC	SunCoat	POL 1	500	-	-	-	-	330126	330130	330134	330138
VS3	PC	SunCoat	POL 1	511	-	-	-	-	330127	330131	330135	330139

Of course, it's possible to get the frames with other lenses (i.e. RX lenses), see our catalogue Optics, Special optics and frames. Items with blue background are stock items and will normally be delivered within one day.

MULTILENS AB

Box 220, 435 25 Mölnlycke, Sweden

Visiting address: Skinnefjällsvägen 1

Phone: +46 (0)31 88 75 50

Fax: +46 (0)31 88 39 77

info@multilens.se, www.multilens.com

